

LUBE OIL (USED)
RE-REFINING
TECHNOLOGY

Pre-Treatment / Dewatering
Distillation / Diesel Removal
Solvent Extraction
Hydrotreating
Fractionation



*turning waste
into a resource*



LUBE OIL (USED) RE-REFINING

Used oil re-refining is the process of restoring used oil to new oil by removing chemical impurities, heavy metals, moisture and dirt. FENIX offers Innovative & Environmentally Friendly Solution for used oil re-refining, specially suited for small & medium size plants.

HOW IT WORKS?

Turn to waste oil recyclers
Turn the earth into a
better place to live

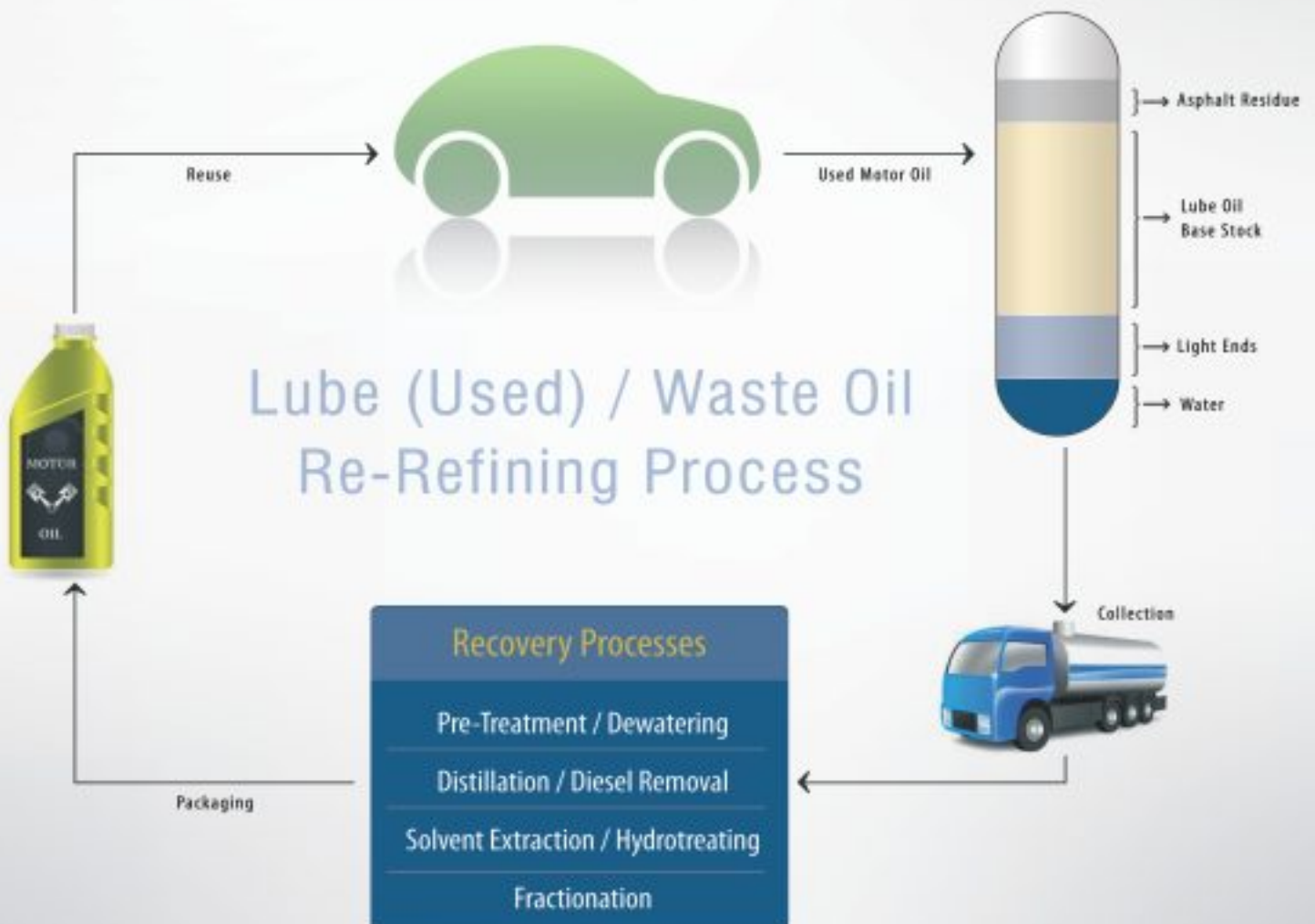

ООО «ТИ-СИСТЕМС» ИНЖИНИРИНГ И ПОСТАВКА ТЕХНОЛОГИЧЕСКОГО ОБОРУДОВАНИЯ

Интернет: www.tisys.ru www.tisys.kz www.tisys.by www.tesec.ru www.ти-системс.рф

Телефоны: +7 (495) 7774788, 7489626, 5007155, 54 Эл. почта: info@tisys.ru info@tisys.kz info@tisys.by

Re-refining Processes

A] Pretreatment and Dewatering

Filteration and dewatering of waste oil by decantation, light hydrocarbons removed by distillation

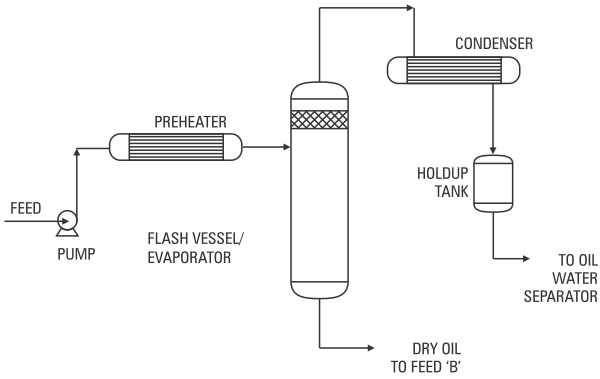

B] Diesel Removal

Removal of Diesel fraction by distillation.

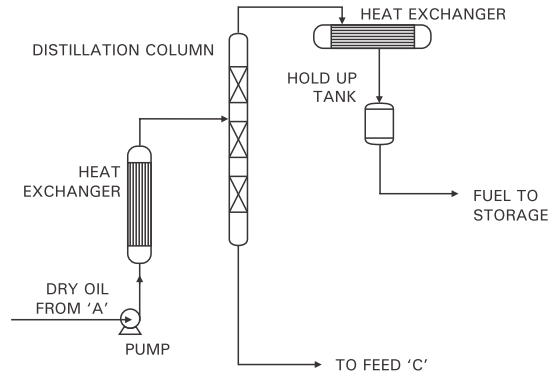

C] Asphalt Removal

Removal of asphaltic fraction by thin film evaporator. High temperature and high vacuum are needed.

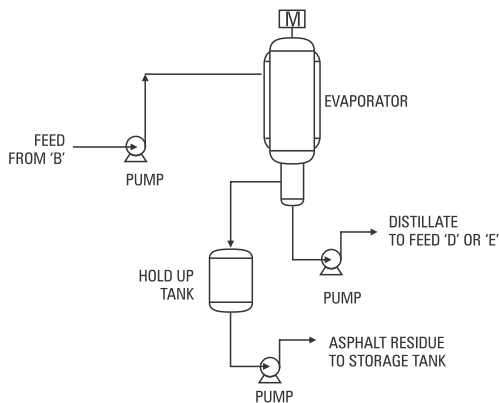

D] Solvent Extraction / Finishing

After removing water, light hydrocarbons and asphaltic fraction, chemical treatment of the waste oil by solvent extraction or hydrogenation

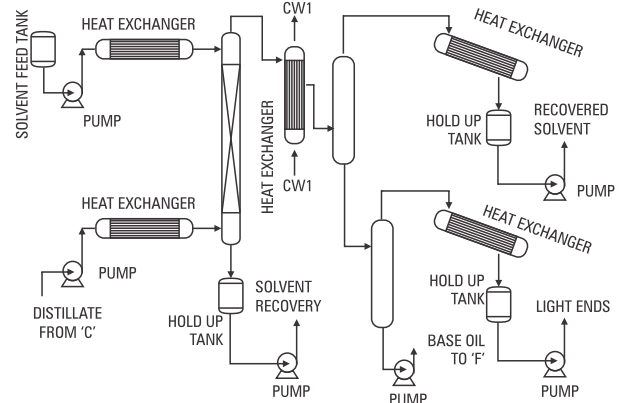

E] Hydrotreating

After removing water, light hydrocarbons and asphaltic fraction chemical treatment of the waste oil by hydrogenation.

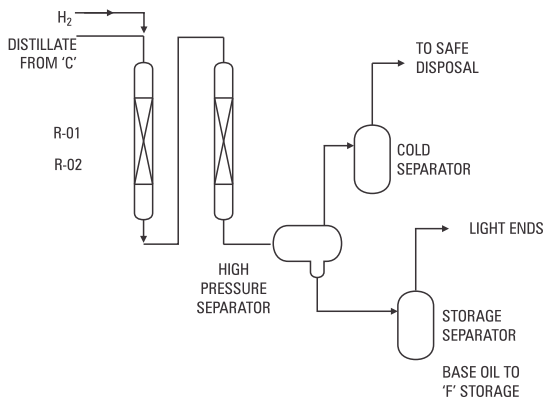

F] Fractionation

Recovering different cuts of base oil according to their boiling points.

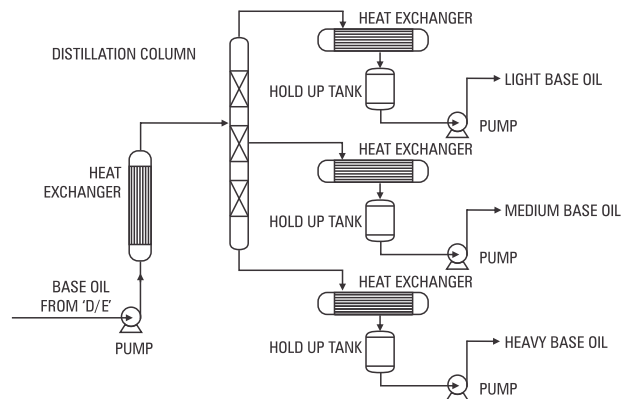

FILM EVAPORATOR

Film evaporator are used to strip solvents down introduced at the top of the wiper blades on to the vertical unit. Evaporation of the solvent moves down the evaporator wall. is high pressure steam or oil.



g, Istanbul, Turkey.

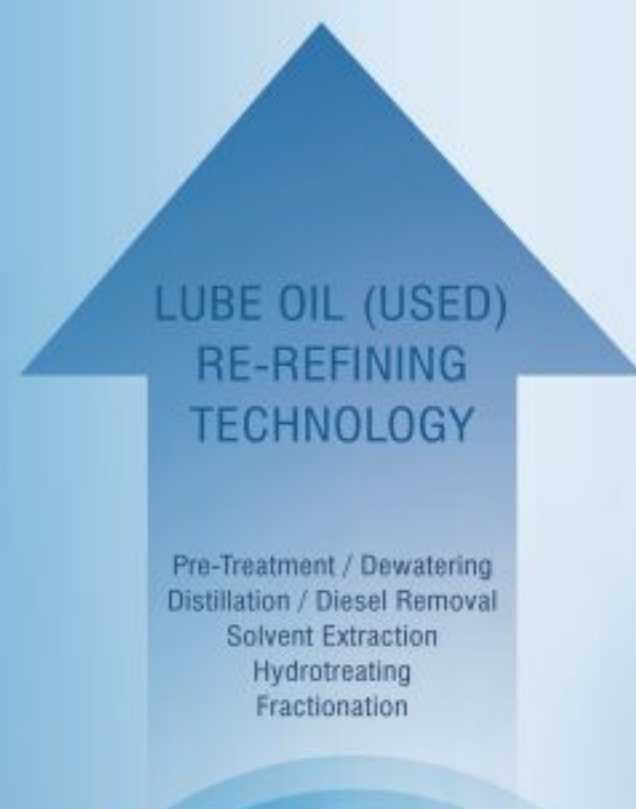

LUBE OIL (USED) RE-REFINING TECHNOLOGY

- Pre-Treatment / Dewatering
- Distillation / Diesel Removal
- Solvent Extraction
- Hydrotreating
- Fractionation



turn
into



Fenix Process Technologies Pvt. Ltd.

K 6/1, Malini
Erandwane Co-op. Housing Society
Near Mangeshkar Hospital
Opp. Sevasadan School
Erandwane, Pune - 411 004
India

ООО «ТИ-СИСТЕМС» ИНЖИНИРИНГ И ПОСТАВКА ТЕХНОЛОГИЧЕСКОГО ОБОРУДОВАНИЯ

Интернет: www.tisys.ru www.tisys.kz www.tisys.by www.tesec.ru www.ти-системс.рф

Телефоны: +7 (495) 7774788, 7489626, 5007155, 54 Эл. почта: info@tisys.ru info@tisys.kz info@tisys.by